

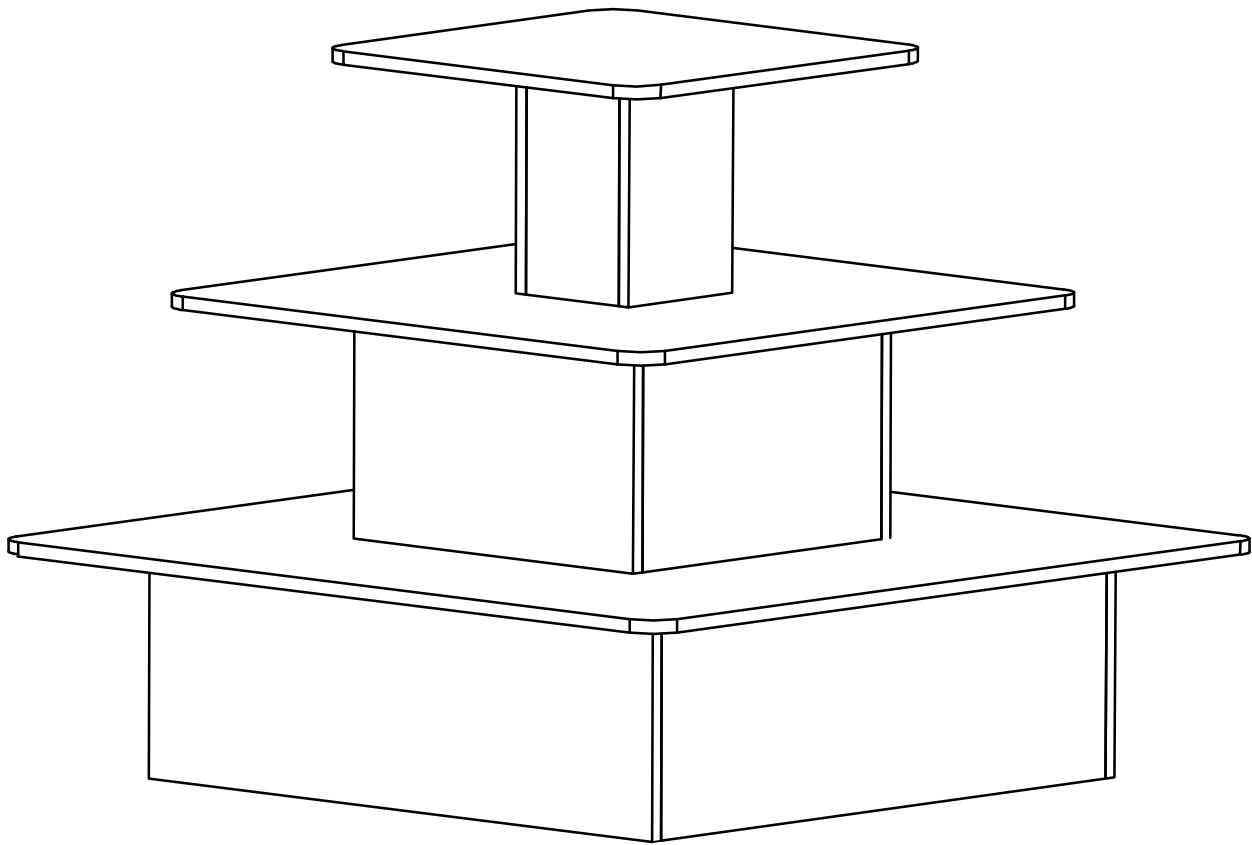









firefly
store solutions

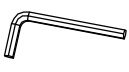

A	B	C	D	E	F	G	H	I
56PCS	16PCS	32PCS	4PCS	32PCS	32PCS	4PCS	4PCS	1PCS
 4*30	 4*15	 $\varnothing 8 \times 30$						

T-SQ- ASSEMBLY INSTRUCTION

1



firefly
store solutions

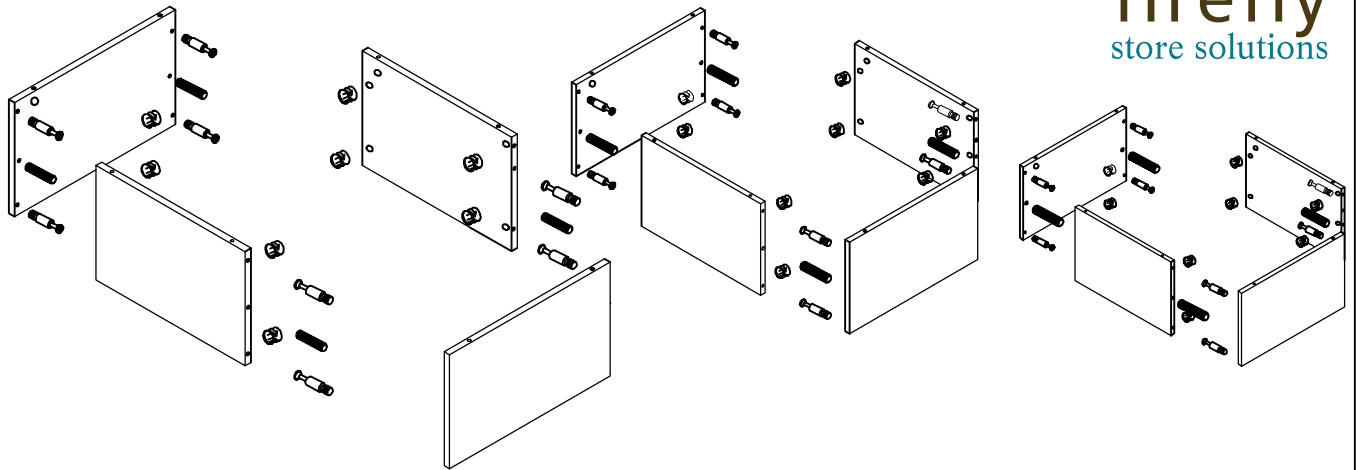

24

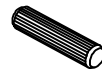

12

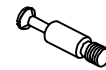

24

2

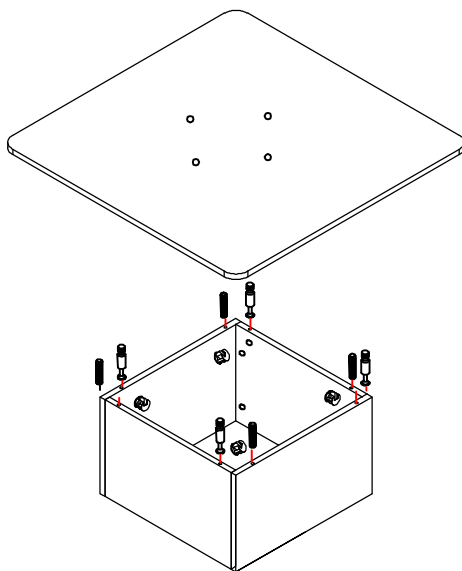

4

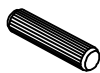

4



4

3

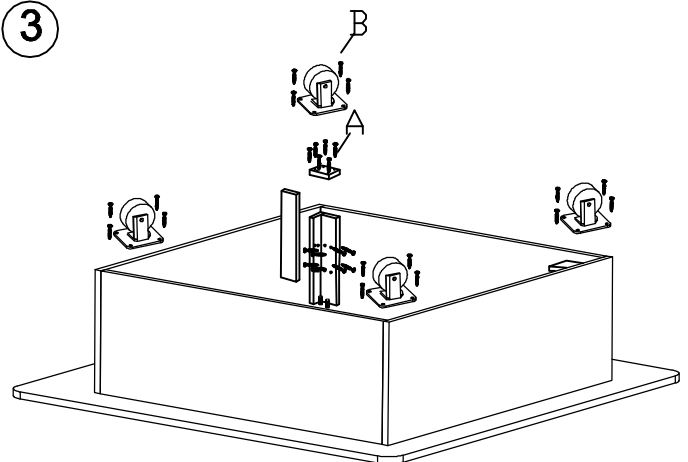

A

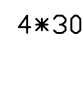

4*30

56

B

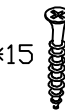

4*15

16



8



4

4



firefly
store solutions

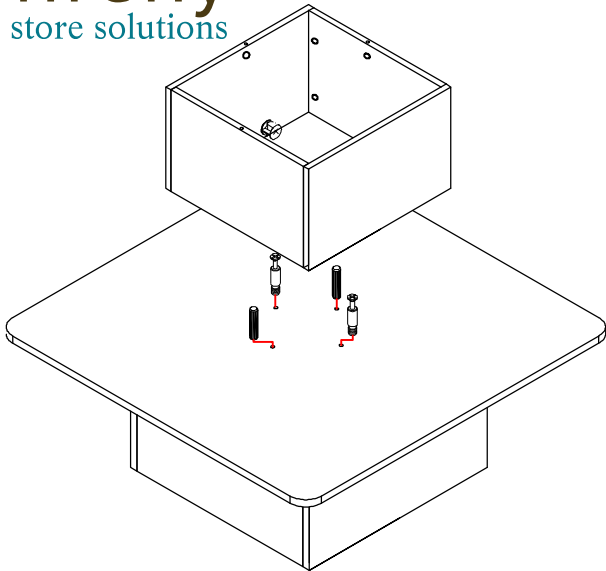

2

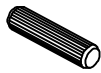

2

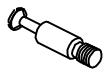

2

5

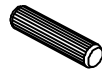
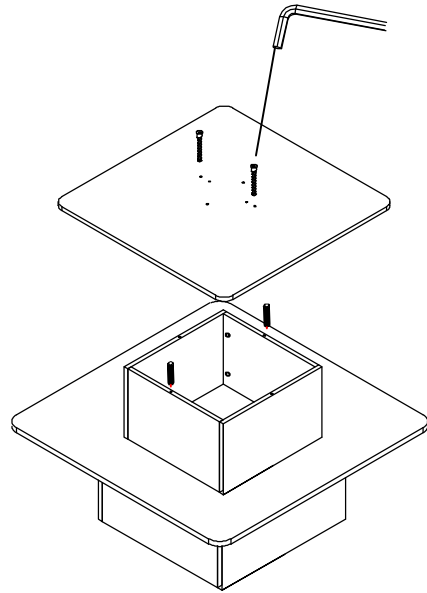

2



2



2

6

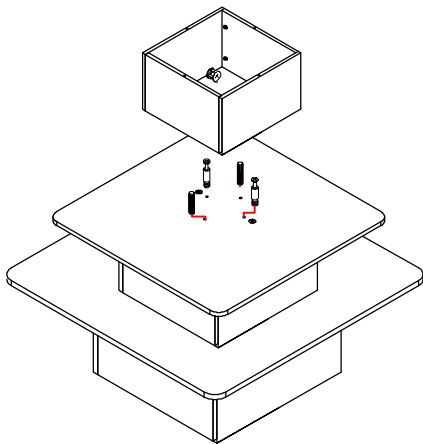

2



2

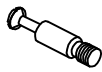

2

7

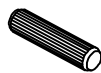
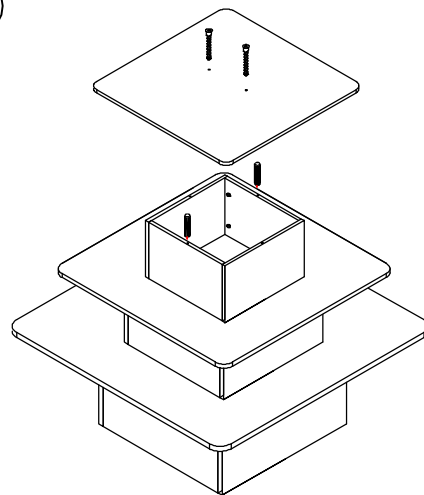

2



2



2